

Axio Imager 2

A New Dimension in Performance



The Standards: Light Microscopy for the Toughest Challenges in Materials Analysis and Quality Control



We make it visible.

Axio Imager 2

Visionary Performance

Whether in R&D, quality control or failure analysis, the challenges facing materials microscopy are becoming greater every day. With the triedandtested Axio Imager system platform from Carl Zeiss you will be able to win these challenges. The Axio Imager microscopes offer the very highest quality: sharper images, higher optical and operational performance with greater comfort – not only in research, but also in routine applications. Axio Imager 2 stands out thanks to its sophisticated operating concept and flexible interfaces for external communication and network connections. And Carl Zeiss' future-oriented modular concept means that these durable and robust systems will be able to cope with any future requirements that arise. Several outstanding features of this second-generation Axio Imager are:

- an optimized operating concept
- improved optics with superb contrast and excellent resolution
- forward-looking stand concept for upgradeability
- innovative design for maximum stability and vibration-free work
- optional automated functions for enhanced operating comfort
- exceptional ergonomics for stress-free use
- an integrated system approach for digital imaging solutions providing high quality reproducible results

With this second-generation Axio Imager Carl Zeiss is responding to the increasing demands of industry and academia. Put your faith in a reliable, powerful and cost-effective analysis platform and in the optimized quality of light microscopy.

*Cover image: cast iron with spherulitic graphite, polished.
Circular Differential Interference Contrast
EC Epiplan-APOCHROMAT 50x/0.95
With kind permission of Dr. H.-L. Steyer, Struers, Kesselsdorf,
Germany*

Contents

The Optics	4
The Contrasting Techniques	6
The Areas of Application	8
The Software	10
The Cameras	12
Confocal Laser Scanning Microscopy	13
The Design	14
The Ergonomics	15
Specifications	16
System Overview	18





The Optics

A New Quality Before Your Eyes

The new Axio Imager generation is the result of the latest innovations in optical design. Carl Zeiss has taken its renowned optical performance to new heights once again and has carefully designed and optimized all relevant components. Discover the visible advances that have been made in image contrast and resolution.

The illumination concept

Obtain brilliant image quality

An innovative illumination concept has been specially developed for the Axio Imager, enabling you to see your specimen in brightfield and darkfield with unprecedented quality, minimized stray light and imaging that is virtually aberration-free. Outstanding image contrast is achieved, especially in interference contrast, even at very high magnifications.

Further information
can be found at
www.zeiss.de/objectives



The objective series

Experience enhanced contrast (EC)

To obtain comprehensive image information, you need to use a wide range of objectives. With the Axio Imager objective series Carl Zeiss has provided solutions for all levels of optical requirements and price / performance categories.

EC EPIPLAN objectives

An economical, all-around series of objectives, which have been achromatically corrected with minimum optical strain for an impressive quality DIC, and, in addition, providing a flat field image for a 23 mm field of view. They are available in brightfield or brightfield/darkfield versions. Differential Interference Contrast in circularly polarized light is also possible with all EC EPIPLAN objectives using only a single C-DIC prism.

EC Epiplan-NEOFLUAR objectives

The particularly high-contrast EC Epiplan-NEOFLUAR objectives, which have high degree of correction and minimized optical strain, enabling you to achieve sharp C-DIC and a flat, in focus, 25 mm field of view – ideal for viewing fine color and structural details, e.g. lamellae in spherulitic graphite. Available as DIC/C-DIC, Brightfield/Darkfield, Pol and LD (long working distance) versions, they also offer the additional benefits of long working distances and high numerical apertures.

EC Epiplan-APOCHROMAT objectives

The EC Epiplan-APOCHROMAT objectives satisfy the very highest demands. They are ideal for imaging color and structural details in the sub-micrometer range and are renowned for offering the best optical correction and highest numerical apertures. Based on ICS optics from Carl Zeiss, these innovative Enhanced Contrast objectives perform at the limits of what optics can achieve with regard to contrast and image fidelity.



*More options, faster handling:
the reflector turrets with Push&Click modules*

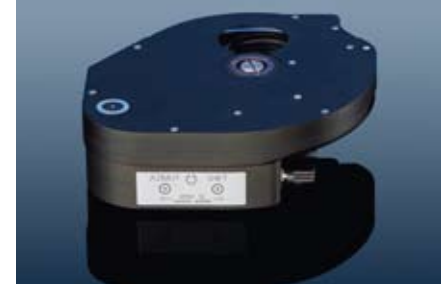

*Greater comfort, simple change of
contrasting techniques: the modulator
turret for interference contrast*

The tube lens turret

Increase your flexibility

With its expanded magnification range comprising a total of five intermediate magnifications, the Axio Imager tube lens turret offers greater variability when it comes to adapting the desired field of view. The tube lens turret is available in two models. 1) Encoded: this model allows manual operation of the tube lens turret (magnification change) while providing automatic feedback of the user selection for reliable and repeatable documentation, scaling factors and measurements. 2) Motorized: this model offers you additional operating comfort for your system solutions by automatic selection based on user-defined configurations. The tube lens turret offers yet another advantage: the use of a focusable Bertrand lens, an important component for the easy observation of the objective exit pupil.

The modulator turret

Easy to operate

Switching quickly and easily from interference contrast to other techniques – the Axio Imager modulator turret has been developed precisely with this goal in mind. Each of the four positions can be easily selected with a simple turn. The motorized model is particularly easy to operate. When switching to interference contrast, the correct prism with the setting you have previously defined is automatically activated. If you switch to brightfield or darkfield, the path is cleared automatically for fast and, above all, reproducible results.

The reflector turret

Fast switching made easy

All Push&Click contrast modules can be stored securely in six or ten positions and activated as needed using manual or motorized operation.

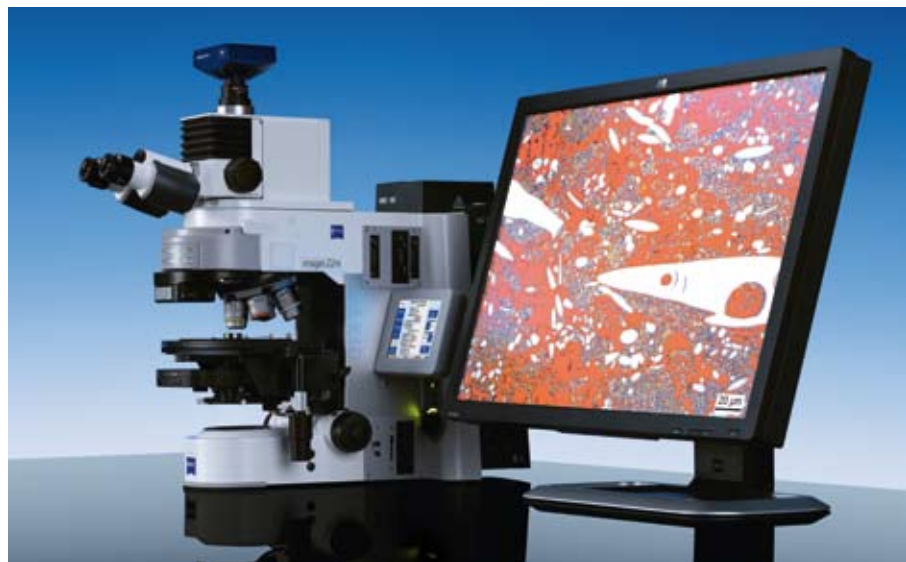

*Monitor: Al/Al₂O₃
composite material
Dirk Staudenecker,
University of Applied
Sciences, Materials
Engineering Working
Group, Aalen, Germany*

Motorized apertures

Maintaining constant image quality

Using the motorized aperture and luminous field diaphragms you can achieve error-free, reproducible illumination settings and, consequently, constant image quality. System integrated motorization guarantees you comparable results and higher productivity by automating the workflow.

The nosepiece

Seven eyes see more

The Axio Imager nosepiece provides room for up to seven objectives. You now have a sufficient number of objectives to use the entire standard magnification series from 1x to 100x. Naturally, it is also possible to combine objective types, for example reflected light and transmitted light objectives. Seven eyes – or room for seven objectives – also mean that it is no longer necessary to exchange the objectives, saving you time and increasing safety.

The Contrasting Techniques

Observing in New Dimensions

New imaging options improve the visualization of your samples. The developments we make at Carl Zeiss lead to new discoveries in research and more reliable test results. This applies not only to standard, but also, in particular, to sophisticated contrasting techniques, like the innovative C-DIC method. Axio Imager 2 will clearly enable you to enhance your results.



August Köhler, Zeiss pioneer and one of the pioneers in microscopy.
The illumination principle named after him revolutionized microscopy.

Brightfield and darkfield

Maximum homogeneity and a stray light free image background

In brightfield the Axio Imager provides homogeneous illumination and exceptional contrast while, in darkfield, the background is so dark that the technique has earned a new name: ADF – Advanced Darkfield. By minimizing disturbing stray light and reducing the longitudinal color aberration of the illumination optics, this darkfield is suitable for the most challenging of samples and impresses even when faced with the finest of structures. Switching between techniques only requires a simple turn. The motorized stand models allow you to work particularly quickly and conveniently.

KLA-Test structures, period $1.6 \mu\text{m}$
EC Epiplan-APOCHROMAT $50\times/0.95, \infty/0$, camera-adapter $0.63\times$

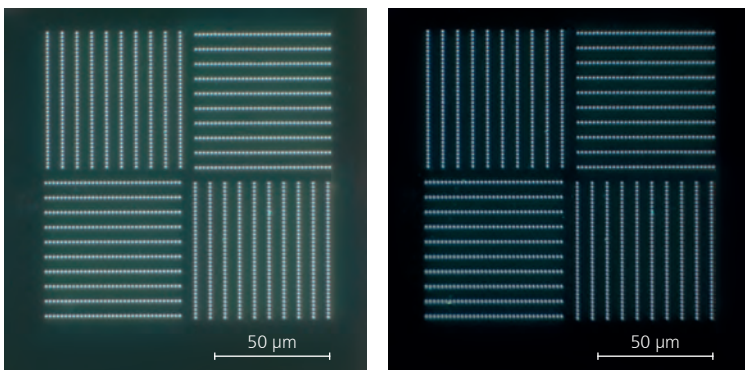

Before: if the rules according to Köhler are not precisely followed only inferior contrast images are possible, even with the best objectives.

After: ADF – Advanced Darkfield from Carl Zeiss. The result speaks for itself.

C-DIC

Perfect for all structures

Circular Differential Interference Contrast (C-DIC) is a polarization-optical technique which, in contrast to ordinary Differential Interference Contrast (DIC), uses circularly polarized light. This technique has a number of decisive advantages for the contrasting of differently aligned object structures. The specimen no longer has to be rotated for best image contrast and quality, as is the case in basic DIC. With C-DIC it is simply enough to adjust the position of the C-DIC prism to adjust for best image quality whether it is for contrast and/or resolution independent of sample orientation. And all this is possible using one C-DIC prism for a homogeneous unsurpassed quality image.

Cast iron with spherulitic graphite, polished.
Images: same position and same magnification, but with different contrasting techniques. Specimen preparation and image interpretation: Dr. H.-L. Steyer, Kesselsdorf, Germany

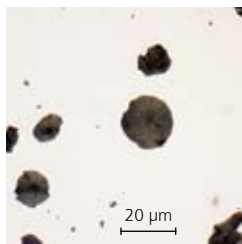

Brightfield:

Classic brightfield allows you to identify only the spherulitic formation. Matrix: white (bright), graphite: black (dark).

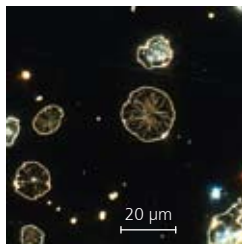

Darkfield:

Unevenness in the polished surface (such as grooves of the phase boundaries between graphite and matrix or notches) clearly reveals the shape of the spherulites and thus the polishing quality. Structural features within the cut spherulites can be identified. Starting from the crystallization nucleus, the cut surfaces of the graphite segments become visible in their divergent orientation (preferred direction of crystallization). Incomplete polished spherulites contain bright points and more extensive bright areas.

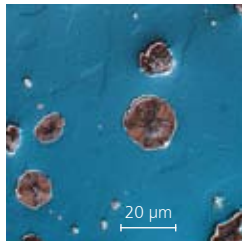

Circular Differential Interference Contrast (C-DIC):

The matrix is contrasted on the basis of the polishing relief. Hard and soft structural constituents become visible, as does what remains of the polishing striae (exclusively mechanically polished).

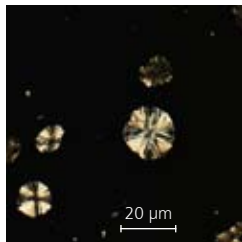

Polarization (crossed polars):

The optical activity, in particular anisotropy, makes the structure inside the spherulites clearly visible.

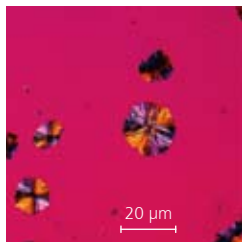

Polarization with additional lambda compensator:

This technique allows optimal contrasting of the structure inside the spherulite section. The interference colors make it possible to see even more details than with simply crossed polars.

The Areas of Application

Opting for Versatility

Axio Imager 2 is an investment in the future, whether in the area of research, testing or failure analysis. Here you will find a system integrated platform that offers you the perfect support for your applications. Time and again the modular structure and application-specific components will adapt to the growing and changing needs faced in our fast paced world.

The applications

Opaque or transparent

The range of materials and samples encountered in quality control, materials testing and research is vast. Axio Imager offers the perfect solution for performing analyses. Metallic structures, composites, glass, wood and ceramics can be analyzed just as effectively as polymers, liquid crystals or semiconductor-based MEMs, wafers and photovoltaic elements, for example.

Contrasting

Competence in all contrasting techniques

Additional information helps you to make decisive advances. You can choose from a variety of contrasting techniques to achieve optimum optical quality for your applications: in reflected light it is possible to observe your samples in brightfield, darkfield, Differential Interference Contrast (DIC), Circular Differential Interference Contrast (C-DIC), polarization or fluorescence contrast, while in transmitted light, you can examine your samples in brightfield, darkfield, Differential Interference Contrast (DIC), polarization or circular polarization.

The sample area

For samples from just a few μm to 63 mm in height

You can adjust the sample space individually to suit your particular sample. The size can be adjusted within wide ranges, depending on the configuration. If you are using a reflected light stage support in combination with a reflected light stage, it is possible to examine samples of up to 63 mm in height, while with a transmitted light stage support and transmitted light stage a height of 45 mm can be achieved.



The stage carrier can be removed or its height adjusted by hand.

The sample space can be adjusted continuously for sample heights from 0 to 63 mm.



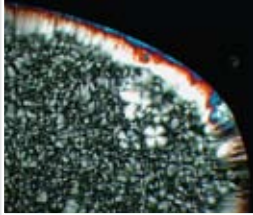

Liquid-crystalline phase of [C14mim]Br
Polarization contrast EC EPIPLAN 10x/0.20 at
100 °C in a THMS600 Linkam heating stage

Anna Getsis and Anja-Verena Mudring, Faculty
of Chemistry and Biochemistry, Solid-State
Chemistry and Materials, Ruhr-University
Bochum, Germany



Magnetic domains on a silicon-iron electrical
sheet Kerr microscopy
EC Epiplan-NEOFLUAR 20x/0.50

Dr. Rudolf Schäfer, Leibniz Institute for
Solid State and Materials Research Dresden,
Germany



Bundle of stretched polyelectrolyte molecules
Rhodamine G stain with fluorescence
LD EC Epiplan-NEOFLUAR 100x/0.75

Konstantin Demidenok, Leibniz Institute of
Polymer Research Dresden e. V., Germany

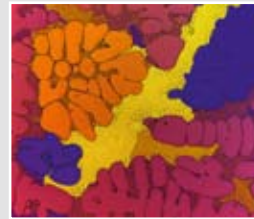

AlNi_{3.5} anodized according to Barker
Polarization contrast
EC Epiplan-NEOFLUAR 20x/0.50

ACCESS e.V. Aachen and Foundry Institute
of RWTH Aachen University, Germany



Tetrahedral inclusions in glass
Brightfield

SCHOTT AG, Corporate Research and
Technology Development, Mainz, Germany



Maraging steel recast structure, nital etch
with white, unetched areas
Differential Interference Contrast
EC Epiplan-NEOFLUAR, 50x/0.80

Sébastien Reymann, University of Applied
Sciences, Materials Engineering Working
Group, Aalen, Germany

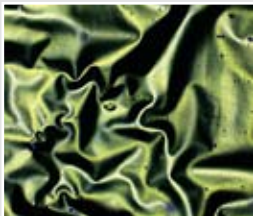

Layer of gold detaching from a silicon wafer
Brightfield ACHROPLAN 10x/0.25

Fraunhofer Institute for Manufacturing
Technology and Applied Materials Research,
Department for Bonding Technology and
Surfaces, Bremen, Germany

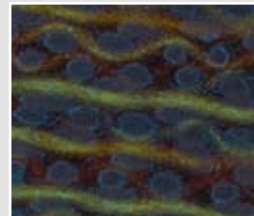

Structure of the surface of a furniture wood
Darkfield EC Epiplan-
APOCHROMAT 10x/0.30

Carl Zeiss MicroImaging GmbH,
Light Microscopy, Göttingen, Germany

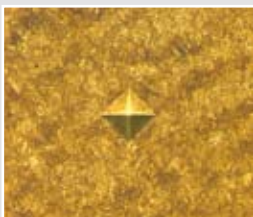

Microhardness impression in a maraging steel
Brightfield EC Epiplan-NEOFLUAR, 50x/0.80

Sébastien Reymann, University of Applied
Sciences, Materials Engineering Working
Group, Aalen, Germany



Stress cracks in acrylate layer
Brightfield ACHROPLAN 10x/0.25

Fraunhofer Institute for Manufacturing
Technology and Applied Materials Research,
Department for Bonding Technology and
Surfaces, Bremen, Germany

The Software

Utilizing Modularity

Requirements and areas of application in material research and design are changing. Modular and customizable, the AxioVision image analysis software and its application focused systems such as Particle Analyzer and NMI (for analysis of non metallic inclusions in steel), combine with the Axio Imager 2 to offer you maximum flexibility and capability when analyzing your images.

AxioVision Basic

AxioVision allows you the automated control of your ZEISS microscope to acquire, analyze and document features such as thermal deformations, inclusions or crystalline microstructures in your samples in a single operation. Only AxioVision enables you to benefit from the ZVI image format, developed by Carl Zeiss especially for microscopy. The quality, content and significance of your valuable images are retained with no loss of information and with the added benefit of integrated documentation of the imaging conditions, essential for repeatability and validation of your data. Depending on your requirements, the functionality of your selected system can be expanded to include various modules or adapted to individual applications, so that you have an expandable solution for your microscopy applications.

MosaiX

Developed to enable the acquisition of large objects, MosaiX scans your samples completely in just one process. An overall image is then created from the individual image tiles. This serves as an ideal overview image for navigating around the sample or as the basis for further analyses. From the MosaiX image measurements can be performed that cross image fields – the tiles present no restriction – allowing you to gain valuable insights into the context and relationships of features of interest.

Topography

Using this module you can quickly and simply generate height maps of your samples from Z stacks, either automatically or interactively. The surface structures can be clearly displayed in different modes, for example Texture Projection, Wire Frame, Surface Rendered, and from different perspectives in three dimensions. Using the flexibility of the AxioVision ZVI image format, height information is stored in the topographic image alongside the visual data. On this basis you can then measure and visualize height profiles across a sample, which can be shown as measurement lists and processed further at any time, or perform automated image analysis.

Particle Analyzer

As a system designed for industrial testing, this fully automated solution for the measurement and analysis of particles in accordance with international standards can be used wherever particulate filters need to be analyzed or residual dirt and cleanliness analyses are performed: in the automotive or pharmaceutical industry for example. Complete samples can be analyzed in a single step and the particles classified automatically. The measurement parameters can be adapted simply and quickly to your needs,

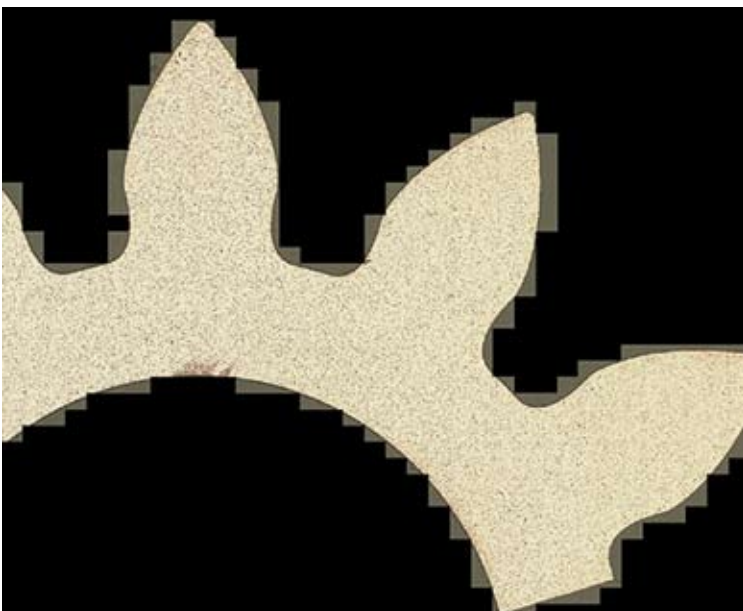

MosaiX image of a gearwheel

Particle Analyzer results view with MosaiX image

enabling you to save time and achieve a considerably higher degree of quality. The system allows you to obtain reproducible results that comply with the standards even for the very smallest particles. Internal test specifications can, of course, be integrated.

NMI System

Together with experienced steel experts from industry, Carl Zeiss has developed the NMI system for automotive-, steel and material industry – a system that allows you to determine the content of non-metallic inclusions in steel in accordance with current international standards. Following a structured workflow, you can analyze the non-metallic inclusions in a single operation and obtain meaningful results in the form of images and tables. Once it has been set up, the system will generate images independently – even on multiple samples. Inclusions are recorded in full, even if they are larger than the image field of your camera. Following the measurement, both the classification results and the gallery of the largest inclusions are conveniently displayed. NMI offers you standard-compliant analysis, whether you are measuring in accordance with DIN EN 10247, DIN 50602, ASTM E 45, ISO 4967 or JIS G0555, in one measurement procedure.

Grains

With this module you can determine the grain size of a wide variety of materials – using the automatic or the semi-automatic intercept method – in accordance with DIN EN ISO 643, ASTM E 112 or ASTM E 1382. Additional standards are also available using the Comparison method. The three measurement methods, ranging from fully interactive through to automatic, allow the performance of fast analyses. With the help of a wizard, you define the measurement procedure once – in just a few steps – right through to the customized report. In the case of the automatic method, sophisticated image-analysis algorithms facilitate the extremely rapid detection, reconstruction and analysis of the grains. Images are preprocessed, artifacts are removed and grain boundaries are accurately reconstructed, even in complex structures.

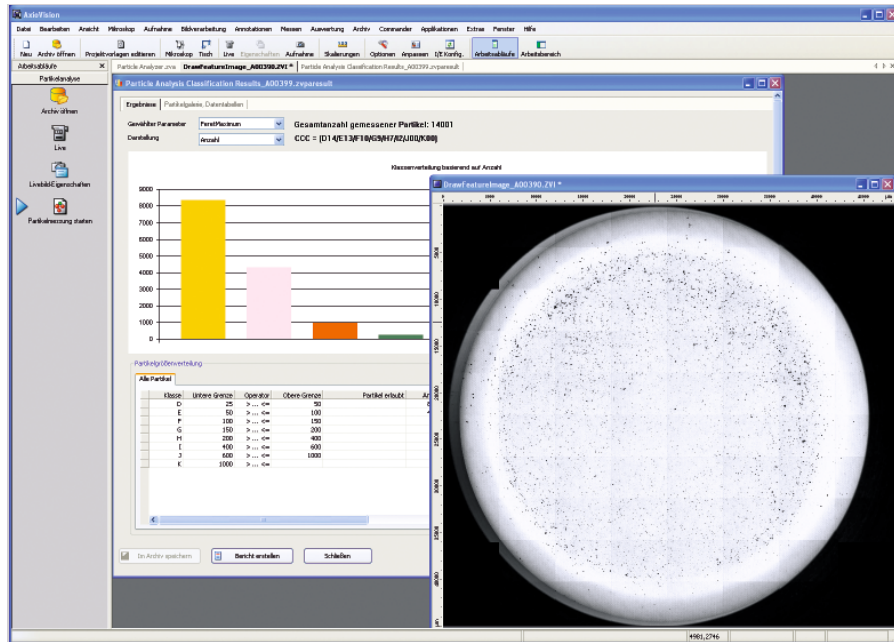

Graphite

Using this module you can record fully automated and with consistent results the shape and size of graphite particles. The data are then available for documentation in a report or export. You can perform analyses in accordance with two standards and therefore satisfy internal standards or external guidelines: by determining size and shape in accordance with EN ISO 943 or nodularity in accordance with SAE J 1887.

Multiphase

Using the Multiphase module, you can determine the proportion of any number of phases in your sample. You can also effortlessly analyze the sizes of the objects. The measurement values are recorded clearly in a class list and a chart. An evaluation based on image analysis, all the requirements of a multiphase analysis and the associated data belonging to each sample are stored in a hierarchically structured database.





Comparative Diagrams

The tried-and-tested method of analyzing samples using comparative diagram charts has now been transferred conveniently to the screen. The images of the samples to be examined are displayed on the screen together with the comparative diagrams to facilitate easy assessment – in the correct magnification, even when the objective is changed. Overlaying the comparative diagram and micrograph creates additional clarity. As a result, you obtain a report containing tables, as well as a statistical analysis and, of course, images too if desired.

The Cameras

Preserving What You See

Axio Imager 2 provides an outstanding platform for a wide range of cameras, with the AxioCam family from Carl Zeiss forming the ideal combination.

Entry Level	AxioCam ICc1 <i>(Economical and fast 1.4 megapixel camera)</i> 	AxioCam ICc3 <i>(Economical, high-resolution 3.3 megapixel camera)</i> 
Mid-Range	AxioCam MRc <i>(High-quality 1.4 megapixel camera with good signal quality and a large dynamic range)</i> 	AxioCam MRc5 <i>(High-quality 5 megapixel camera with good signal quality)</i> 
High-End	AxioCam HRc <i>(13 megapixel camera with maximum resolution, extremely flexible settings and the maximum possible signal quality)</i> 	



The AxioCam product family

Flexibility and performance

As customized components in the Carl Zeiss systems environment, camera, microscope and software are perfectly matched to form an integrated system solution in digital imaging that opens up new perspectives – in the areas of performance, flexibility and operating comfort and for both research and routine applications. The Axio Imager microscope platform offers great flexibility in camera use thanks to its standardized camera ports (C mount) on the stand and a full range of camera adapters. From digital compact cameras (e.g. from Canon) to the professional, research-grade cameras of the Carl Zeiss AxioCam family of cameras, a wide variety of cameras are supported by the AxioVision image-acquisition and analysis software. The range of AxioCam cameras extends from the economical

AxioCam ICc1 1.4 megapixel camera and high-quality AxioCam MR model right through to the highest resolution, high-end AxioCam HRc camera. All digital cameras from Carl Zeiss are offered complete with a free, entry-level version of AxioVision and guarantee optimal image quality. Some models are also available in a black/white version with an extended sensitivity range. The sophisticated integration of Carl Zeiss cameras delivers important advantages: high speed, correct resolution, an optimized live image and automatic exposure adjustment. All cameras in the AxioCam family are controlled via a uniform user interface in AxioVision. Naturally, you can also adapt the camera operation individually to the wide range of applications you work on.

Confocal Laser Scanning Microscopy

Increasing Resolution

Whether it is used to measure tiny height differences with high precision or examine highly textured surfaces, LSM 700 masters it all. Take advantage of the enormous flexibility offered by confocal microscopy such as surface topography and roughness along with 3D volumetric analysis and more ...

In combination

Greater accuracy

Thanks to the use of selectable laser wavelengths (i.e. violet) in combination with high-aperture precision optics and sensitive detectors, ultra-fine lateral details down to approx. 120 nm (line-space pattern) can be optically resolved and large slope angles detected.

In reflection

Precision from nm to mm

In reflection mode confocal systems are particularly well suited to the 2D and 3D analysis of microstructured surfaces. Low reflection or semi-transparent materials, such as chrome or gold surfaces, can be examined just as reliably. The confocal entry models offer the functionalities of a fast and modern 3D profilometer.

In fluorescence

Brilliant results

In fluorescence mode, confocal systems provide unique information on the chemical composition, mechanical strain or structural contamination of, for example, polymer and fiber materials. Autofluorescent inclusions, phases or particle collections can be analyzed and imaged up to several hundred micrometers deep in the interior of a semi-transparent matrix. Deep voids or cracks can be visualized and measured with the help of fluorescent dyes.

In perfect harmony

LSM 700

Together with Axio Imager.Z2m or Axio Imager.M2m and the powerful EC Epiplan-APOCHROMAT objectives, this high-end system makes it possible to achieve new and exciting research results as well as to perform routine tasks reliably in industry.

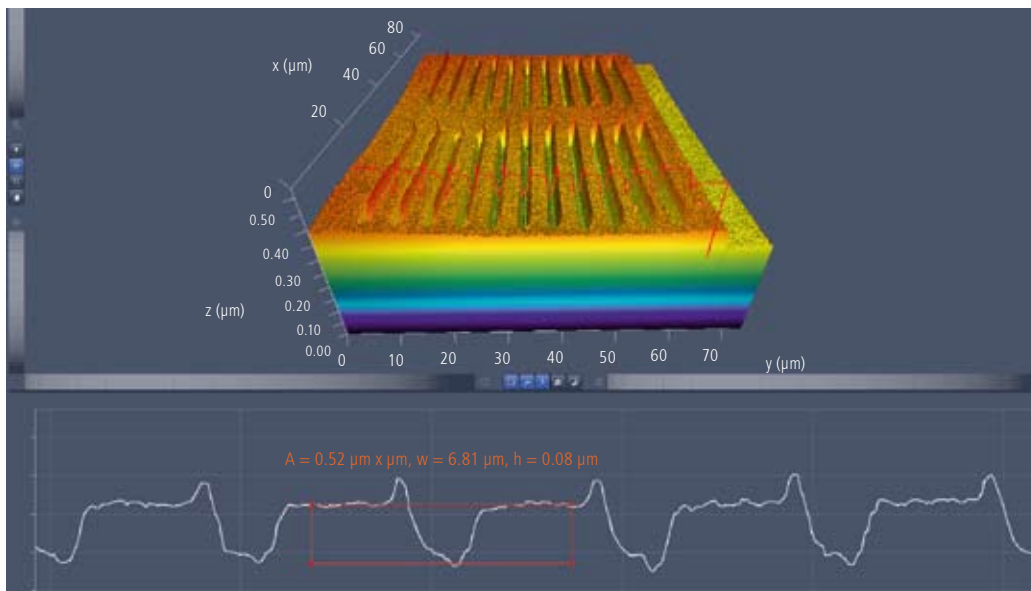

Etched height structure, nominal height 85 nm (material: chrome), 3D surface topography with section of measured profile, EC-Epiplan-APOCHROMAT 50x/0.95, original stack: $85 \mu\text{m} \times 74 \mu\text{m} \times 1.3 \mu\text{m}$, 1168×1017 pixels \times 53 sections

The Design

Stay Flexible

Axio Imager 2's stand design may be pleasing to the eye; however most important of all is the fact that its innovative architecture allows unprecedented flexibility.

The concept behind the stand

Four economical choices

Our professed goal is to relieve a great deal of the strain on you as the user, especially when you are working on the system for long periods. To give you a high degree of flexibility, manual and semi-motorized (A2m, D2m) as well as motorized stand models (M2m, Z2m) are available. Axio Imager is an attractive microscope platform, offering an upgradeable operating concept together with user-friendly and, wherever possible, greatly simplified functions. This means that you can operate the microscope with ease and concentrate fully on your application.

Motorization

Maximizing comfort

The motorization of Axio Imager is the prerequisite for the powerful performance of your imaging system – a system of perfectly matched components that interact for a total integrated system solution. Motorization facilitates quicker results, constant conditions and reproducibility, safe and error-free operation, a significantly reduced number of steps and greater efficiency. Two examples: the motorized apertures and the illumination control, which is automatically adjusted via filter wheels at a constant color temperature. With the motorized Axio Imager stands you are ideally prepared to document large samples – with imaging and analysis that extend beyond the field of view. The Z2m model allows the maximum in upgradability and system performance.

The stable cell

Vibration-free documentation

Stability is essential if you want to attain good results. The core elements of nosepiece, focus mechanism and stage carrier have therefore been designed as a compact, stability-optimized unit. This stable cell has been isolated from the rest of the stand and is thus particularly insensitive to outside thermal influences and vibrations. You will appreciate these outstanding imaging conditions created by the system, especially when working with high magnifications and performing time dependant studies.

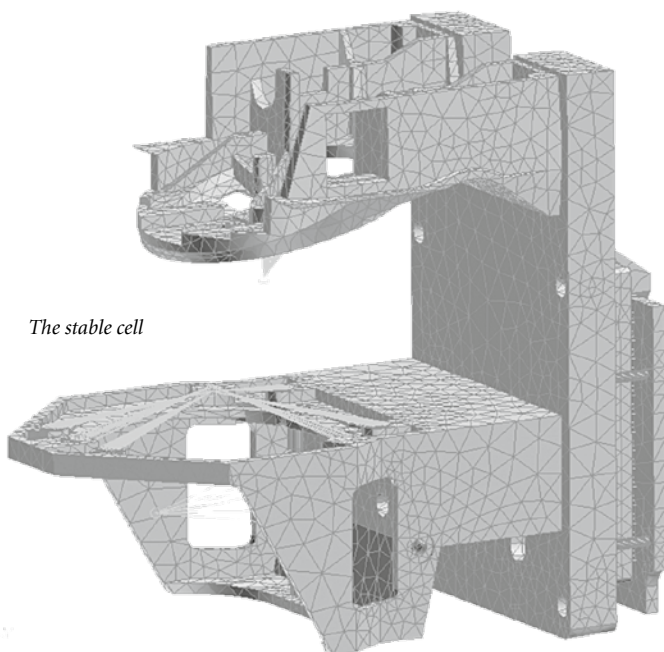

The stable cell

The Ergonomics

Relax While You Work

The touch screen

All key information at a glance

To simplify complex steps, Axio Imager.Z2m and .M2m have all the main functions grouped together on a color touch screen TFT-Display. This allows you to control all motorized components easily at the touch of a button and display and control the microscope status. If required, the integrated light and contrast managers ensure the best possible light and contrast setting. In addition to fixed presets, it is also possible to store complex procedures as individual settings and retrieve them at any time with just the touch of a button. The Axio Imager microscopes are therefore ideal even in a multi-user environment.

The control buttons

Intuitive operation

Axio Imager has a well-designed operating concept. The control buttons, which are arranged ergonomically around the focusing drive, can be easily distinguished thanks to their tactile surfaces. The manual stand has five pre-programmed buttons, while the motorized stand features ten buttons, the functions of which can be freely configured.

The docking station

Remote microscopy

Axio Imager can be remotely controlled using a freely-positionable control panel. This panel includes among other features a focusing drive and illumination control. Other functions can also be programmed, as required.



Docking station



TFT-Display

The panel offers an interface for the TFT-Display and for the lateral X-Y control of the motorized stage. A well developed concept that gives you a greater freedom of movement and is highly ergonomic.

The ergophototube

Relaxed working

With its upright, unreversed image, 50 mm continuous height adjustment, ergonomic, fixed viewing angle of 15° and a continuous horizontal extension of 50 mm, the 50-15-50 ergophototube from Carl Zeiss satisfies the highest standards in terms of comfort and provides unrestricted optical quality in all positions.

Ergophototube



Reflected light filter



Multifunctional control element



Specifications

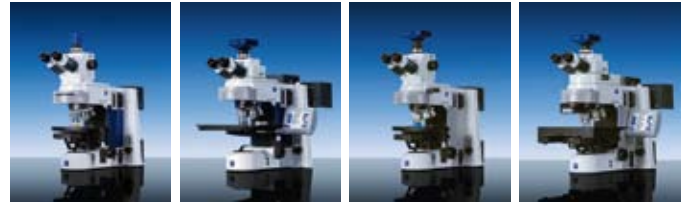

Axio Imager.A2m Axio Imager.M2m Axio Imager.D2m Axio Imager.Z2m

Components	Option	A2 LED	A2	M2p	M2	D2	Z2	A2m	M2m	D2m	Z2m
Stand	manual	+	+	-	-	+	-	+	-	+	-
	motorized	-	-	+	+	O*	+	-	+	O*	+
Encoding	readable by PC	+	+	+	+	+	+	+	+	+	+
Tube lens turret	encoded	O	O	O	O	O	O	O	O	O	O
	motorized	-	-	O	O	-	O	-	O	-	O
Reflector turret	6x encoded	O	O	O	O	O	O	O	-	O	O
	6x motorized	-	-	O	O	O	O	-	+	O	O
	6x motorized ACR	-	-	-	-	-	O	-	-	-	O
	10x motorized ACR**	-	-	-	-	O	O	-	-	O	O
Nosepiece	6x encoded POL	O	O	-	O	O	O	O	O	O	O
	6x encoded HD DIC	O	O	-	O	O	O	O	O	O	O
	6x motorized HD DIC	-	-	-	O	-	O	-	O	-	O
	6x motorized HD DIC ACR	-	-	-	O	-	O	-	O	-	O
	7x encoded HD	O	O	+	O	O	O	O	O	O	O
Modulator turret C-DIC/TIC	manual	O	O	O	O	O	O	O	O	O	O
	motorized*****	-	-	-	O	-	O	-	O	-	O
Modulator turret for transmitted light - DIC	motorized*****	-	-	-	-	-	O	-	-	-	O
Transmitted light LED	-	+	O	+	O	O	O	O	O	O	O
Transmitted-light illumination	manual	-	+	-	-	+	-	O	O	O	O
	motorized	-	-	-	+	-	+	-	-	-	O
Double filter wheel (transmitted light)	manual	-	+	-	O	O	O	O	O	O	O
	motorized	-	-	-	O	-	O	-	-	-	O
Reflected-light illumination	manual***	O	O	O	O	O	O	+	-	+	-
	motorized***	-	-	-	-	-	O	-	+	-	+
Luminous field diaphragm (reflected light)	manual	O	O	O	O	O	O	+	O	+	O
	motorized	-	-	-	-	-	O	-	O	-	O
Aperture diaphragm (reflected light)	manual	O	O	O	O	O	O	O	O	O	O
	motorized	-	-	-	-	-	O	-	O	-	O
Double filter wheel (reflected light)	manual	O	O	O	O	O	O	O	O	O	O
	motorized	-	-	-	O	-	O	-	O	-	O
FL attenuator	manual	O	O	O	O	O	O	O	O	O	O
	motorized	-	-	-	-	-	O	-	O	-	O
Switching reflected light/transmitted light	manual	+	+	-	-	+	-	+	-	+	-
	by means of a software	-	-	+	+	-	+	-	+	-	+
Mixed light using additional power supply unit	manual	+	+	-	-	+	-	+	-	+	-
	by means of a software	-	-	+	+	-	+	-	+	-	+
Focus (z-axis)	manual	+	+	-	-	+	-	+	-	+	-
	motorized 25 nm	-	-	+	+	-	-	-	+	-	-
	High-performance focus (10 nm)	-	-	-	-	-	+	-	-	-	+
TFT-Display	-	-	O	+	-	+	-	+	-	-	+
ApoTome	-	O	O	O	O	O	O	O	O	O	O
Power supply unit	external	-	-	+	+	-	+	-	+	-	+
	internal	+	+	-	-	+	-	+	-	+	-
CAN BUS stages	motorized****	O	O	O	O	O	O	O	O	O	O
Scanning stages	Piezo	O	O	O	O	O	O	O	O	O	O
	DC / stepper motors	O	O	O	O	O	O	O	O	O	O
Fast Z-Piezo insert	with manual stage	O	O	O	O	O	O	O	O	O	O
	with scanning stage	O	O	O	O	O	O	O	O	O	O
Motorized 2TV tube	-	-	-	O	O	-	O	-	O	-	O
Condensers	manual	O	O	O	O	O	O	O	O	O	O
	motorized	-	-	O	O	-	O	-	O	-	O

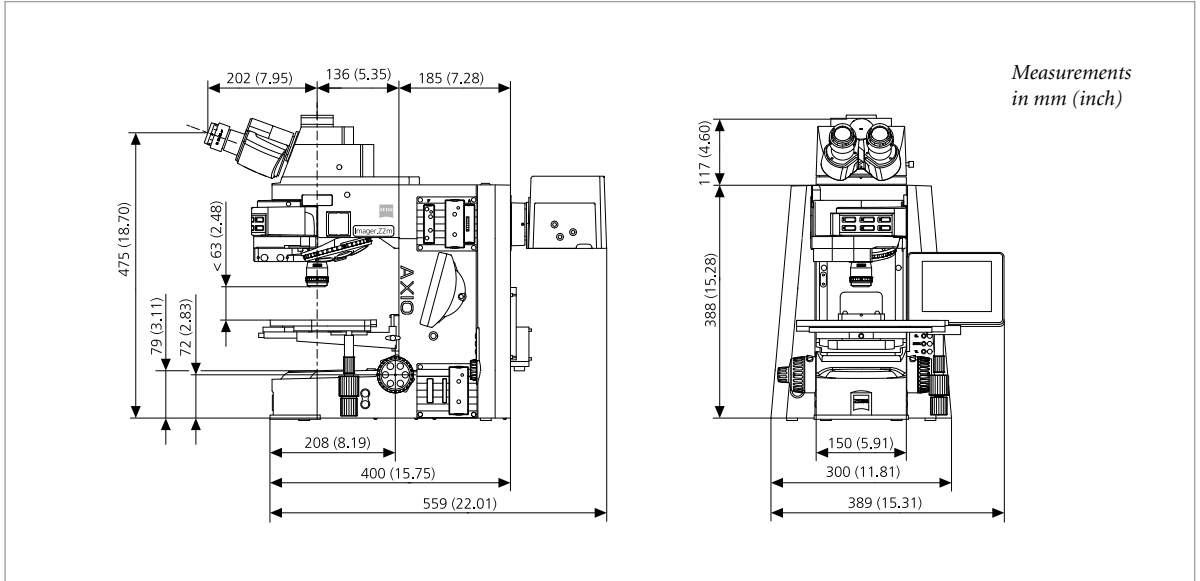

Stand	Axio Imager.A2m	Axio Imager.M2m	Axio Imager.D2m	Axio Imager.Z2m
Contrast manager	-	+	-	+
Light manager	+	+	+	+
TFT-Display	-	+	-	+
Remote control	-	O (docking station)	-	O (docking station)
Height of sample space	0–63 mm (reflected-light stage carrier) 0–45 mm (reflected-light/transmitted-light stage carrier for removable condenser holder) 0–25 mm (reflected-light/transmitted-light stage carrier with condenser holder)			
Depth of sample space	136 mm (distance from optical axis to stand) 121 mm (distance from optical axis to dovetail mount for stage carrier)			
Dimensions	388 (H) x 300 (W) x 400 (D) mm			
Weight (total)	20–30 kg	20–40 kg	20–30 kg	20–40 kg
Weight (stand)	16.6 kg	17.5 kg	16.4 kg	17.0 kg
Eyepiece	Field of view number 23/25			
Objective magnification	1x – 100x			
Objectives	Reflected light: EC EPIPLAN, EC Epiplan-NEOFLUAR, EC Epiplan-APOCHROMAT Transmitted light: N-ACHROPLAN, EC Plan-NEOFLUAR, Plan-APOCHROMAT, C-APOCHROMAT, FLUAR Special: LD EPIPLAN, LD EC Epiplan-NEOFLUAR			
Condensers	Manual/motorized achromatic, manual/motorized achromatic-aplanatic, manual/motorized achromatic-aplanatic Universal, LD and darkfield condensers			
Tubes	Binocular tubes, phototubes, ergotubes and ergophototubes			
Stages	Manual/motorized mechanical stages, 360° pol-rotary stages and scanning stages			
Illumination	Reflected light: 12V 100W HAL, 12V 100W HBO Transmitted light: 12V 100W HAL, 12V LED			
Contrasting techniques	Reflected light: Brightfield, darkfield, Differential Interference Contrast, Circular Differential Interference Contrast, simple polarization, fluorescence Transmitted light: Brightfield, darkfield, Differential Interference Contrast, phase contrast, polarization			

+ = included with stand

O = optional

- = not possible

* = possible to use motorized (6-pos. and 10-pos.) reflector turret

** = ACR function not possible with Axio Imager.D2 and .D2m

*** = all reflected light illuminations contain a motorized shutter

This can be replaced by a high-speed shutter for fluorescence applications (optional).

**** = for use on the Axio Imager.A2, .A2m, .D2 and .D2m, USB/CAN converter 432909 is required

***** = only in connection with motorized nosepiece

System Overview

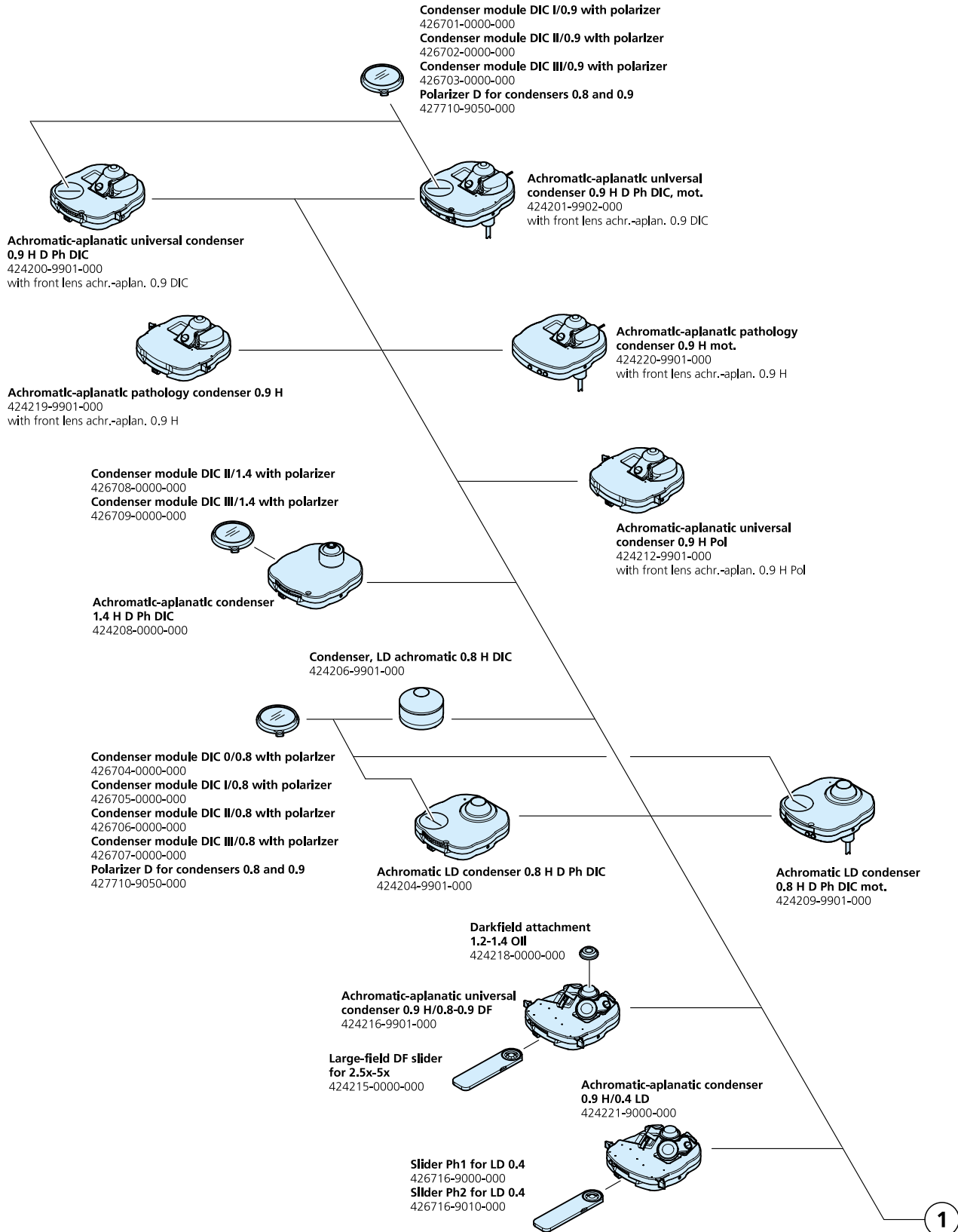

System Overview

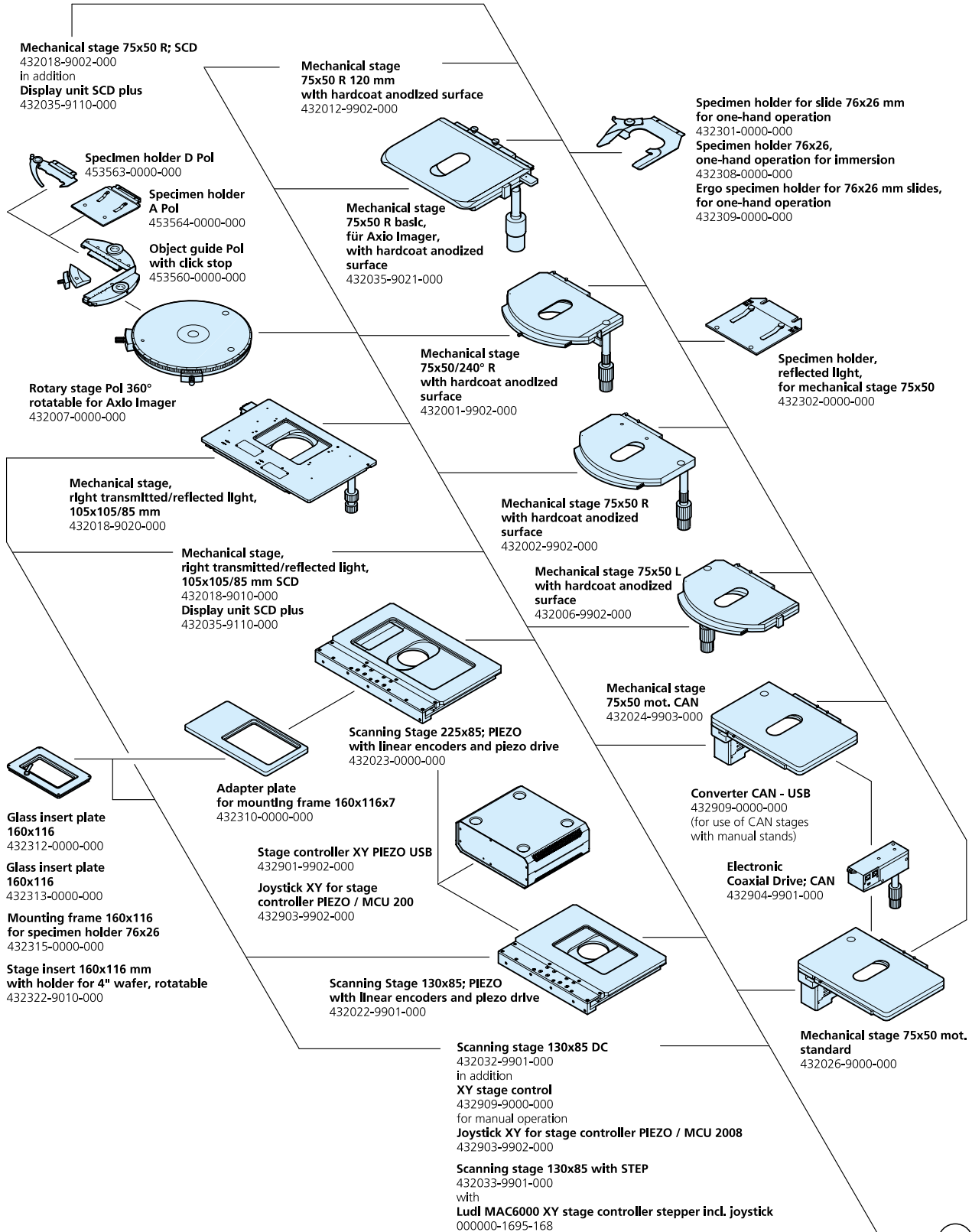

Okulareinlegeplatten
on request

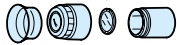

Eyepiece PL 10x/25 Br. foc.
444034-9000-000
Eyepiece E-PL 10x/25 Br. foc.
444234-0000-000
Eyepiece E-PL 10x/23 Br. foc.
444235-0000-000
Eyepiece PL 10x/23 Br. foc.
444036-9000-000



Auxiliary microscope,
d=30 mm
444830-9902-000

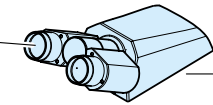

Binocular tube 30°/23,
reversed image,
Axio Imager
425520-9060-000

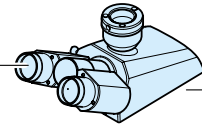

Binocular phototube
30°/23 (50:50), reversed image,
Axio Imager
425520-9070-000

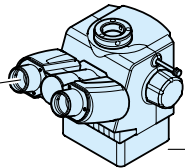

Binocular Ergophototube
20°/23 MAT (100:0/0:100),
upright image variable,
continuous vertical
adjustment 44 mm
425514-0000-000

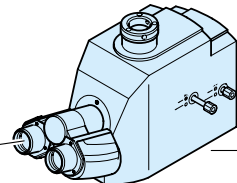

Binocular phototube Pol
15°/23 (100:0/0:100),
upright image including
quartz depolarizer,
425517-0000-000

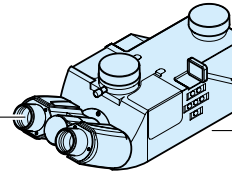

Binocular phototube
30°/25 mot. (100:0/30:70/0:100),
with two camera ports,
reversed image
425504-0000-000

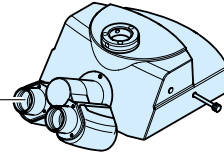

Binocular phototube
30°/25 (100:0/30:70/0:100),
reversed image with
motorized eyepiece shutter
425506-0000-000

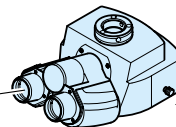

Binocular phototube
15°/25 (100:0/0:100),
upright image, adjustable stop
425503-9901-000

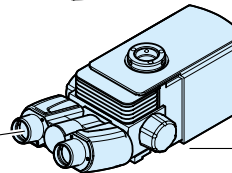

Comfortable binocular
Ergophototube
15°/23 (50:50),
upright image variable,
continuous horizontal
and vertical adjustment
of the binocular component
425515-0000-000

Note:

For tube lens turrets the eyepieces PL 10x/25 Br. foc or PL 10x/23 Br. foc have to be used.

Note:

The tubes 425500-0000-000
425502-0000-000
425503-9901-000
425506-0000-000
and 425515-0000-000

can be combined with a tube lens turret or the center component for multidiscussion equipment.

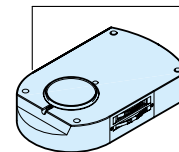
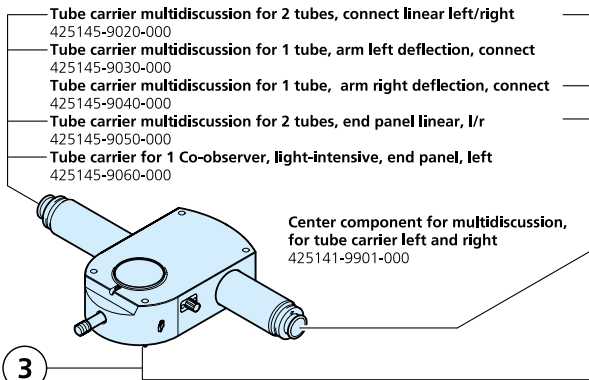

Tube lens 1.25x
425303-0000-000
Tube lens 1.6x
425304-0000-000
Tube lens 2.5x
425305-0000-000
Tube lens 4.0x
425307-0000-000

to be equipped at most with three tube lenses:
5-position tube lens turret, cod., with Bertrand system
425309-9901-000
with tube-lens 1.0x
5-position tube lens turret mot., with Bertrand system
425302-9901-000
with tube-lens 1.0x

Reflector module C-DIC/TIC ACR P&C for reflected light

424929-9903-000
DIC prism C I for modulator turret for EC EPN 5x-20x
426921-0000-000
DIC prism C II for modulator turret for EC EPN 50x-100x
426922-0000-000
TIC prism for modulator turret for EC EPN 5x-100x
426923-9901-000

4-position modulator revolver for circular DIC/TIC
424703-0000-000

4-position modulator revolver mot. for circular DIC/TIC
424704-0000-000

for transmitted light:
Compensator mount 6x20
424705-0000-000

for reflected light:
Compensator mount 6x20 with darkfield stop
424706-0000-000

Analyzer slide D, fixed 6x20
433605-0000-000

Antiglare screen
452163-0000-000

Objectives M 27
ICS objectives
on request

6-position objective nosepiece, HD DIC M27 cod.
424504-0000-000
6-position objective nosepiece, HD DIC M27 mot.
424505-0000-000

7-position objective nosepiece, HD M27 cod.
424501-0000-000
7-position objective nosepiece, HD M27 mot.
424502-0000-000

6-position objective nosepiece, Pol M27 cod.
424503-0000-000
6-position objective nosepiece, HD DIC M27 mot. ACR
424507-0000-000

Objective intermediate ring ACR for cylindrical, short objective sleeve
424508-0000-000
Objective intermediate ring ACR for cylindrical, long objective sleeve
424511-0000-000
Objective intermediate ring ACR for conic, short objective sleeve
424509-0000-000
Objective intermediate ring ACR for conic, long objective sleeve
424510-0000-000

Reflector module brightfield ACR P&C for reflected light
424928-9901-000

Reflector module C-DIC/TIC ACR P&C for reflected light
424941-9000-000

Reflector module darkfield ACR P&C for reflected light
424922-9901-000

Reflector module Polarizer ACR P&C for reflected light
424923-9901-000

Reflector module Pol ACR P&C for HBO 100 for reflected light
424924-9901-000

Reflector module C-DIC/TIC ACR P&C for reflected light
424929-9903-000

Reflector module DIC/Pol red I ACR P&C for reflected light
424938-0000-000

Reflector module DIC/Pol ACR P&C for reflected light
424939-0000-000

Reflector module with analyzer ACR P&C for reflected light
424941-9050-000

Analyzer module DIC ACR P&C
424921-9901-000

Analyzer module DIC ACR P&C shift free
424932-9901-000

Reflector module FL EC P&C
424931-0000-000

Reflector module FL ACR P&C
424933-0000-000

Analyzer module Pol ACR P&C for transmitted light
424937-9901-000

Filter sets for reflector modules FL on request

6-position reflector turret man. cod. for P&C modules
424906-0000-000

6-position reflector turret mot. ACR, for P&C modules
424912-0000-000

6-position reflector turret mot. for P&C modules
424907-0000-000
(included in stands M2m)

10-position reflector turret mot. ACR, for P&C modules
424913-0000-000

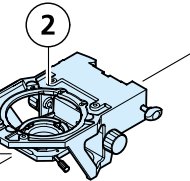

Stage carrier, detachable with condenser carrier for Axio Imager
430707-0000-000

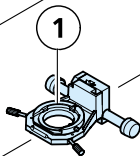

Condenser carrier with vertical adjustment on both sides
430705-0000-000

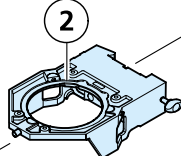

Transmitted-light/reflected-light stage carrier
430704-9901-000

Mechanical stage 75x50 R for reflected light with hardcoat anodized surface
453527-9903-000

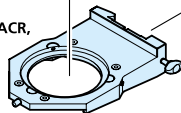
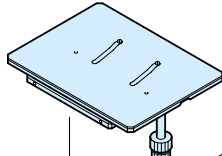

Reflected-light stage carrier, detachable for Axio Imager
430701-9901-000



Polarizer D, fixed removable
427701-0000-000



Polarizer D, 90° rotatable, removable
427706-0000-000



Polarizer rotatable with color filter carrier
427707-0000-000



Polarizer fixed with lambda plate rotatable
445226-0000-000



Circular polarizing equipment D ACR, with rotatable lambda/4 plate for transmitted light
427703-9901-000
including reflector module lambda/4, ACR P&C



Color filter carrier 3x for filter d=32 mm
428305-0000-000



LED illuminator for transmitted light
423904-9902-000



Slider with polarizer for LED illumination
427708-0000-000



Focus Linear Sensor
430703-0000-000
(to be used with stand Z2 and Z2m)



Holder Z for the measuring probe of the Axio Imager
430702-0000-000

Note:

Usable only if no camera path deflecting system on the left side is inserted:

Quartz depolarizer d=32 mm
453653-0000-000

Analyzer slider D/A, fixed
428101-0000-000

Analyzer slider D/A with lambda-plate, 360° rotatable
428102-0000-000

Analyzer slider D/A, 360° rotatable
428103-0000-000

Analyzer slider D/A with lambda-plate, each rotatable +/- 10°
453663-9901-000

Depolarization slider D/A
428105-0000-000



Stop slider with centerable luminous-field diaphragm
423611-0000-000



Stop slider mot. with centerable luminous-field diaphragm
423612-0000-000



Slider with variable rectangular diaphragm
423615-0000-000

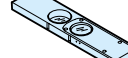

Stop slider with centerable aperture stop
423613-0000-000



Stop slider mot. with centerable aperture stop
423614-0000-000



FL attenuator, discrete
423616-0000-000



FL attenuator, discrete, mot.
423617-0000-000



Double filter wheel, discrete, man. with neutral-density filter set d=25 with 2x4 positions
428319-9000-000



Double filter wheel, discrete, man., 2x4 positions
428300-9901-000



Double filter wheel, discrete, mot., 2x4 positions
428301-9901-000



Neutral-density filter set D/A, d=25
487931-9901-000



Filter set transm. light with neutral-density and color filters, d=25
487935-9010-000

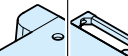

Neutral-density filter set for reflected light, d=25
487935-9020-000



Polarizer slider for reflected light, 360° rotatable
427704-0000-000
Adjusting aid for HBO/XBO lamps
423631-0000-000

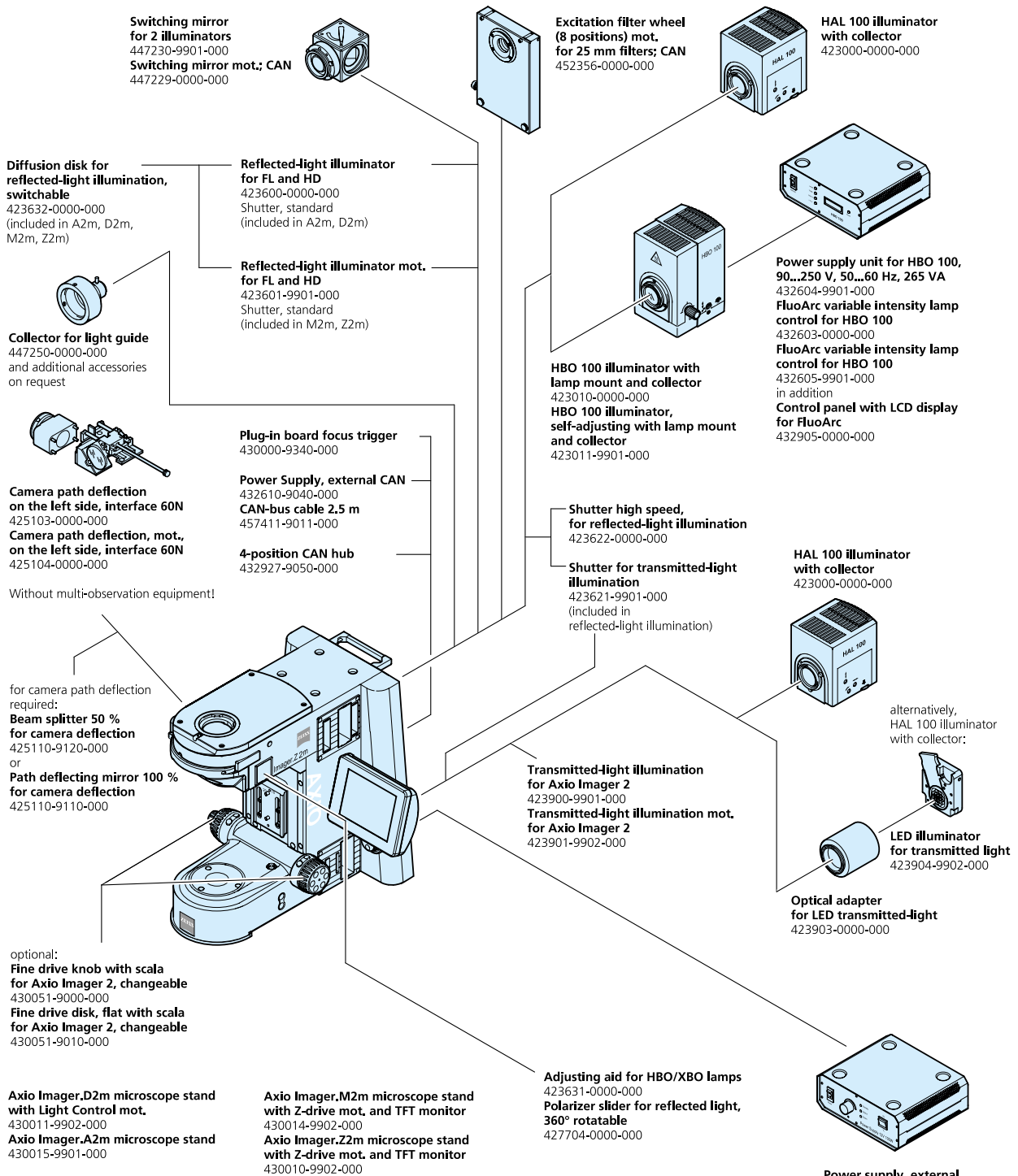

Note:
Always included in A2m and D2m stands:
- **Focusing drive man.**
Always included in M2m stand:
- **Focusing drive mot. basic**
Always included in Z2m stand:
- **Heavy duty focusing drive motorized, stepsize 10 nm**

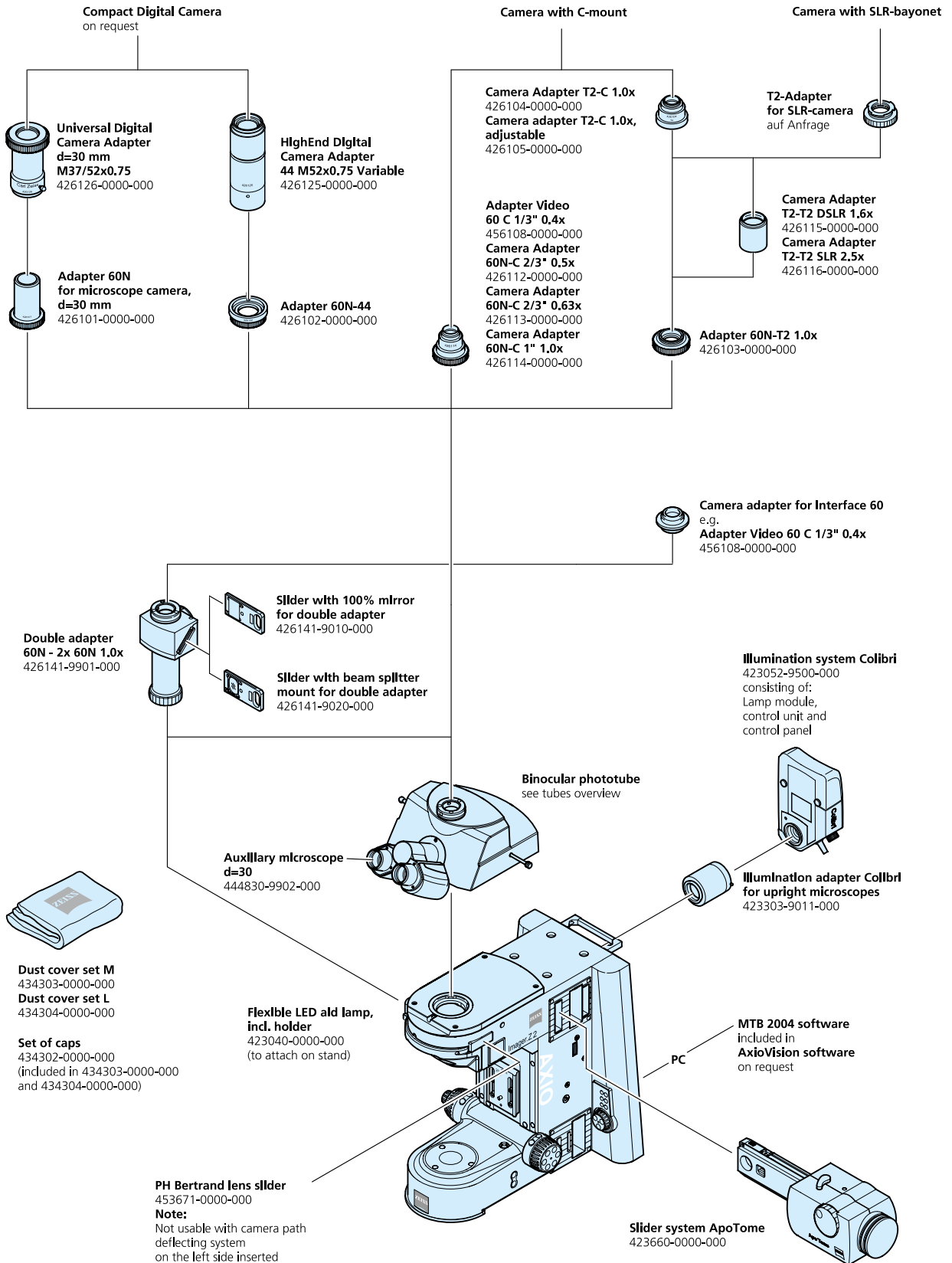



New Horizons in Materials Microscopy

The Future Before Your Eyes

Axio Imager 2 from Carl Zeiss is a system platform that can be used for demanding quality control and materials analysis tasks, as well as for the development of new materials. The stands are exceptionally flexible and can be expanded to cover a wide range of applications, meaning that Carl Zeiss can offer you a high degree of adaptability in line with your future requirements. The combination of a motorized stand with additional motorized components, plus camera and control software, enables the systems to be used optimally for your applications, with maximum efficiency and comfort.

Axio Imager 2 from Carl Zeiss is just as well suited to research as it is to routine applications and sets new standards in materials microscopy. The stable cell provides ideal conditions for vibration-free work, and – thanks to the sophisticated production technology from Carl Zeiss – you can be confident that you are buying a product that will stand the test of time.

Carl Zeiss MicroImaging GmbH
07740 Jena, Germany

Industrial | Göttingen Location
Phone : +49 551 5060 660
Telefax : +49 551 5060 464
E-Mail : micro@zeiss.de

www.zeiss.de/AxiolmagerMAT